

A p p e n d i x

B

TTL IC 데이터 북

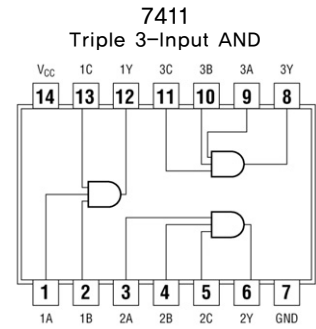

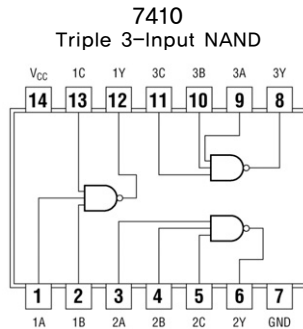
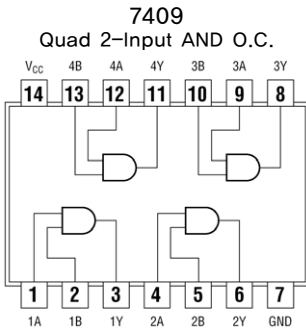
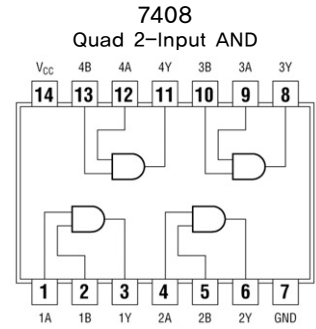
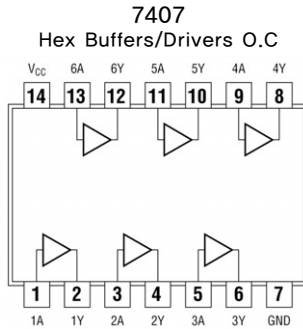
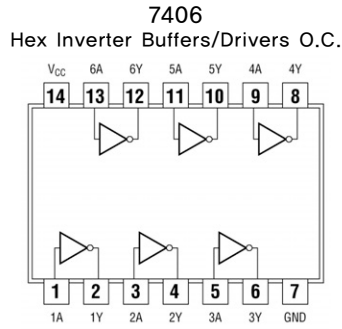
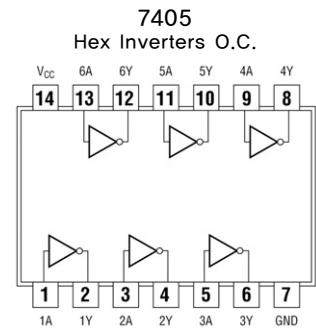
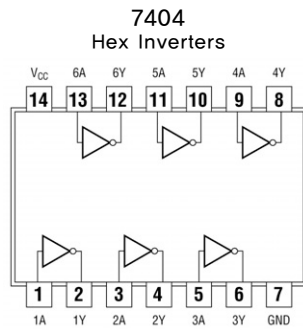
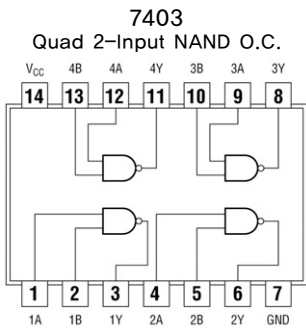
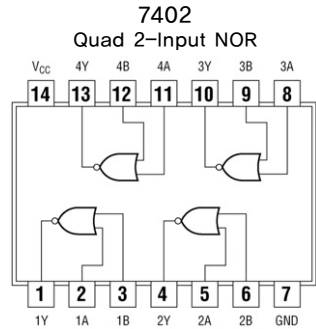
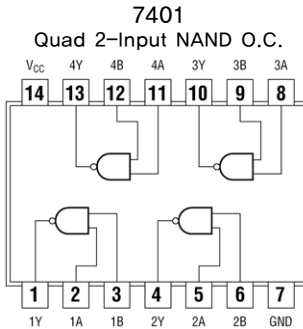
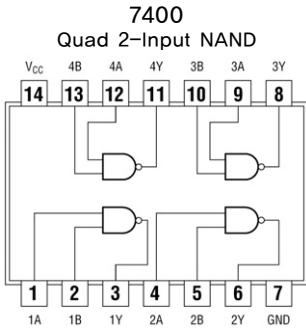

7412
Triple 3 Input NAND O.C.

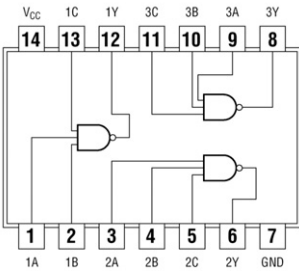

7413
Dual 4 Input NAND Schmitt Trigger

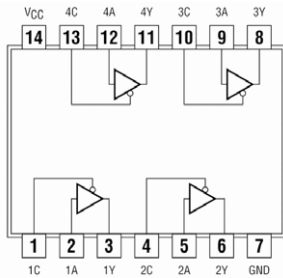

7414
Hex Schmitt Trigger Inverters

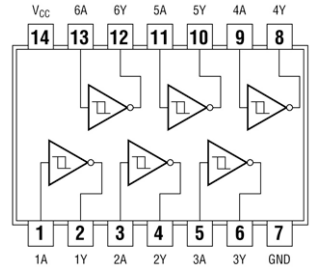

7415
Triple 3-Input AND with O.C.

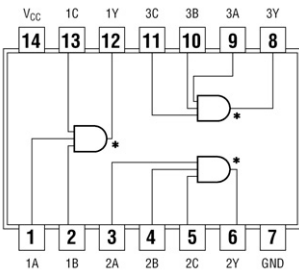

7416
Hex Inverter Buffers/Drivers O.C.

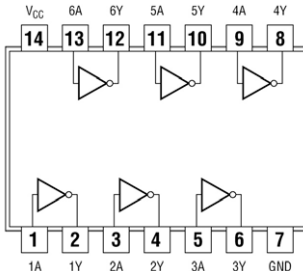

7417
Hex Buffers/Drivers O.C.

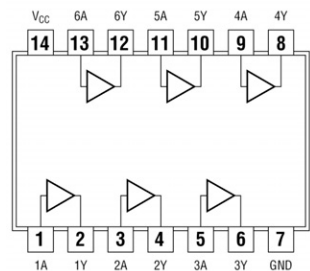

7418
Dual 4-Input NAND Schmitt Triggers

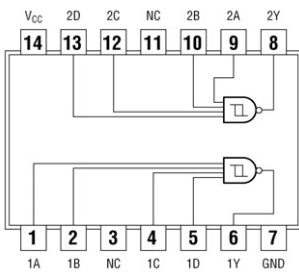

7419
Hex Schmitt Trigger Inverters

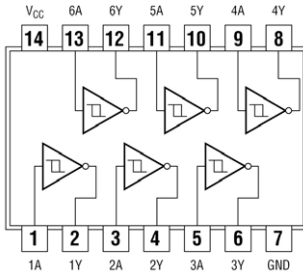

7420
Dual 4-Input NAND

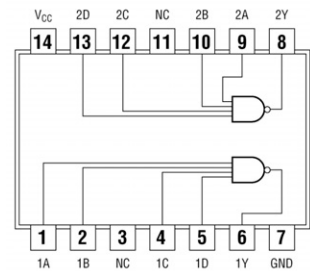

7421
Dual 4-Input AND

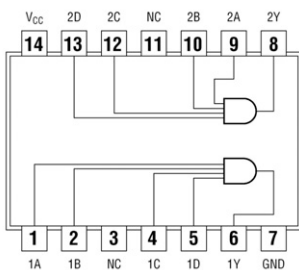

7422
Dual 4-Input NAND O.C.

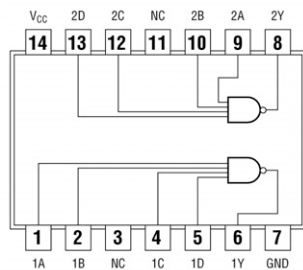

7423
Expandable Dual 4-Input NOR with strobe

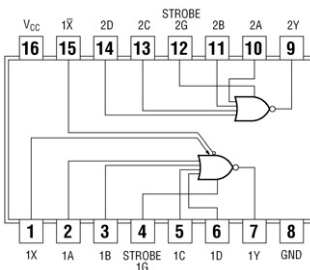

7424
Quad 2-Input NAND Schmitt Triggers

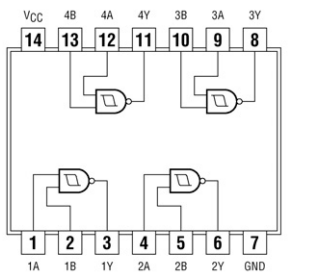

7425
Dual 4-Input NOR with Strobe

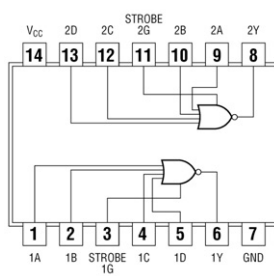

7426
Quad 2-Input High Voltage Interface NAND

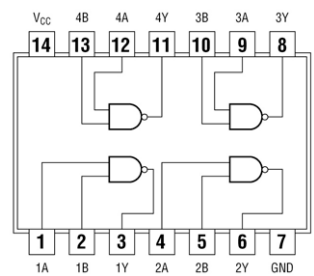

7427
Triple 3-Input NOR

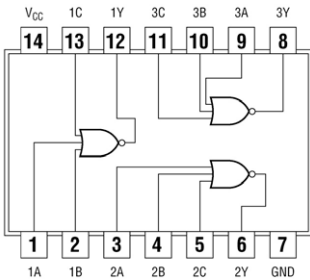

7428
Quad 2-Input NOR Buffer

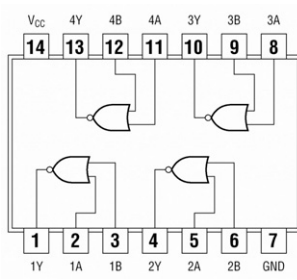

7430
8-Input NAND

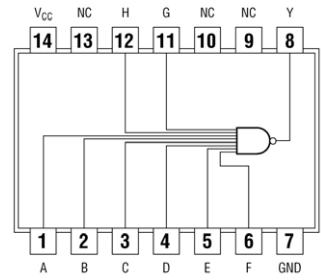

7431
Delay Elements

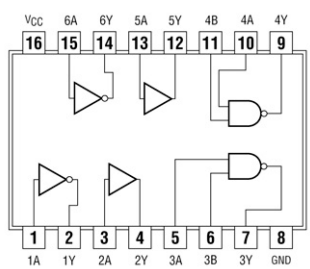

7432
Quad 2-Input OR

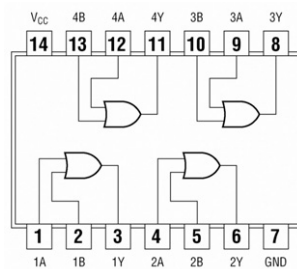

7433
Quad 2-Input NOR Buffers O.C.

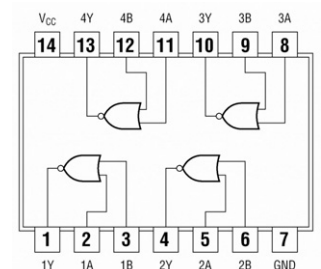

7437
Quad 2-Input NAND Buffers

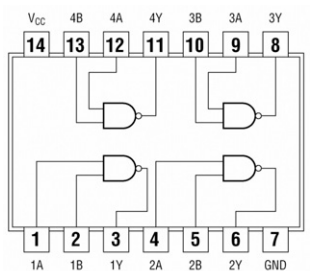

7438
Quad 2-Input NAND Buffers O.C.

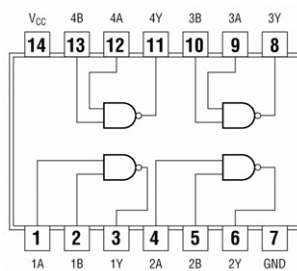

7440
Dual 4-Input NAND Buffers

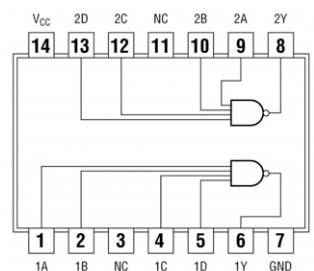

7442, 7443, 7444
4-Line to 10-Line Decoder, Excess-3 to Decimal Decoder, Excess-3 Gray to Decimal Decoder

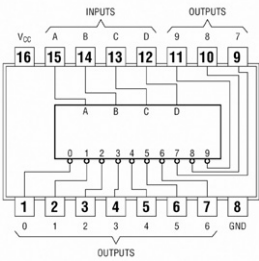

7445
BCD-to-Decimal Decoder/Driver 30V O.C.

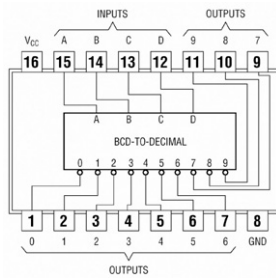

7446, 7447
BCD-to-Seven Segment Decoders/Drivers

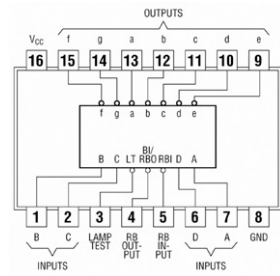

7448
BCD-to-Seven Segment Decoders/Drivers

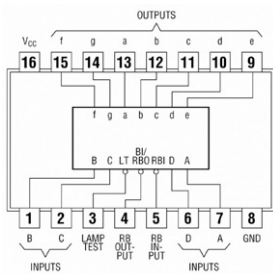

7449
BCD-to-Seven Segment Decoders/Drivers

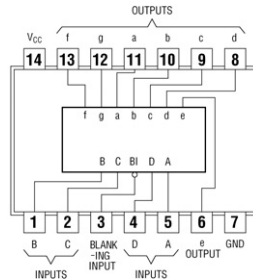

7450
Dual 2 wide 2-Input AND-OR-INVERT

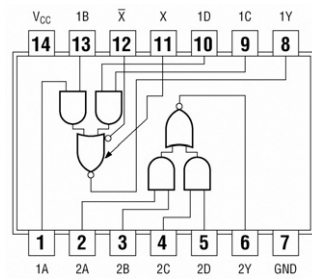

7451(7451, 74S51)
Dual 2 wide 2-Input AND-OR-INVERT

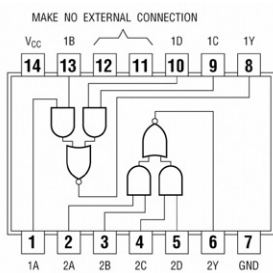

7451(74LS51, 74HC51)
Dual 2 wide 2-Input AND-OR-INVERT

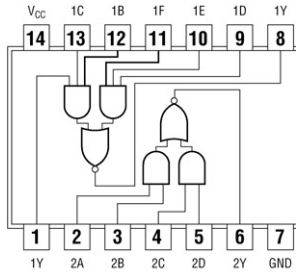

7453
4 wide 2-Input AND-OR-INVERT

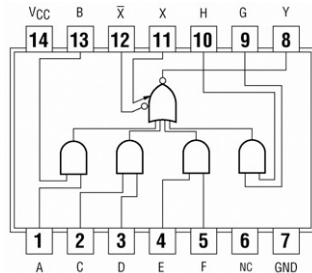

7454
4 wide 2-Input AND-OR-INVERT

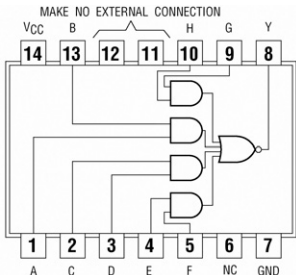

7454(74LS54)
4 wide 2-Input AND-OR-INVERT

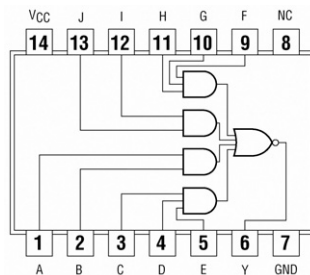

7455
Expandable 2 wide 4-Input AND-OR-INVERT

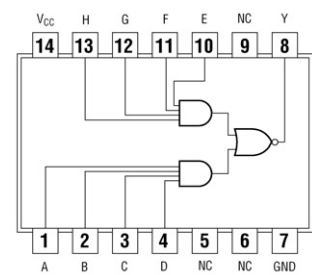

7456, 7457
50 to 1 Frequency Division
60 to 1 Frequency Division

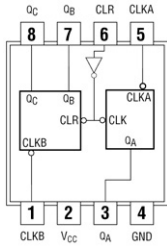

7460
Dual 4-Input Expanders

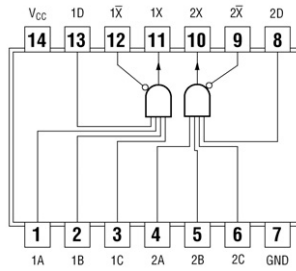

7463
Hex Current Sensing Interface Gates

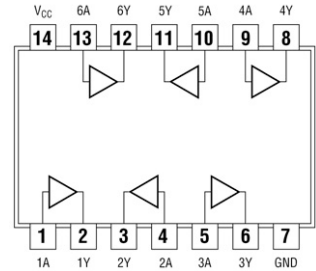

7464
4-2-3-2 Input AND-OR-INVERT

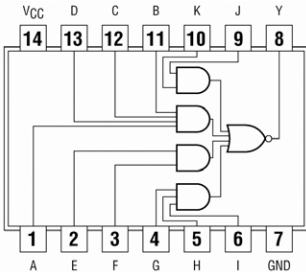

7465
4-2-3-2 Input AND-OR-INVERT O.C.

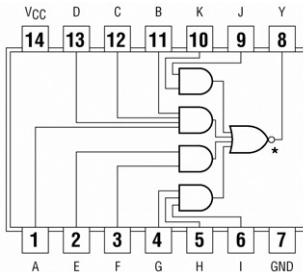

7468, 7469
Dual 4-Bit Decade Counters
Dual 4-Bit Binary Counters

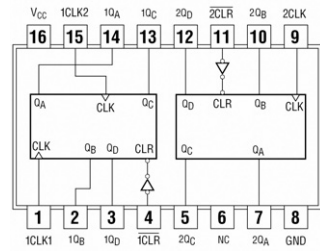

7470
AND-gated J-K Flip Flop with Preset and Clear

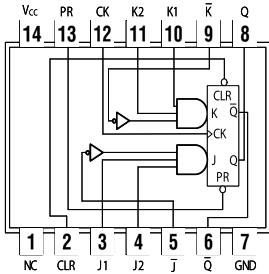

7472
AND-gated J-K Flip Flop with Preset and Clear

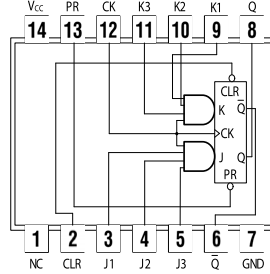

7473
Dual J-K Flip Flops with Clear

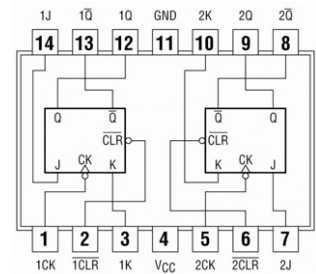

7474
Dual D-Type Flip Flops with Preset and Clear

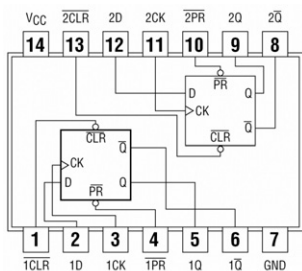

7475
4-Bit Bistable Latches

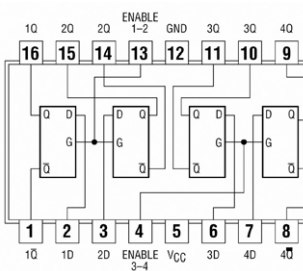

7476
Dual J-K Flip Flops with Preset and Clear

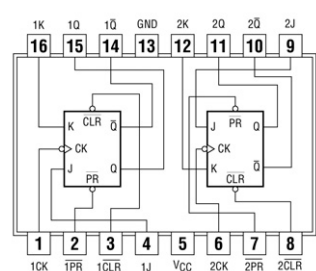

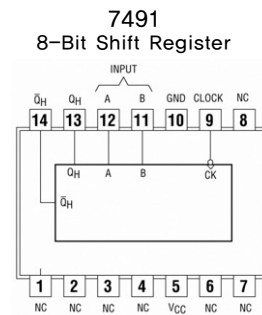
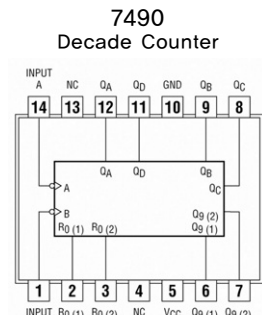
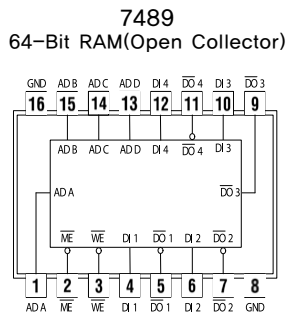
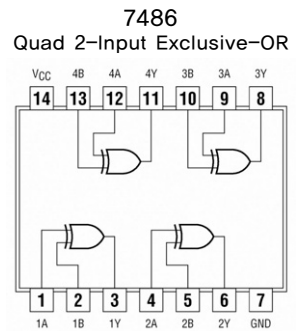
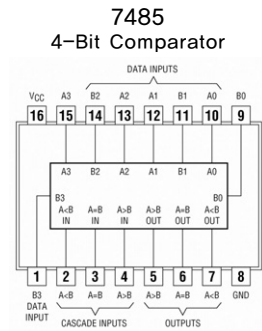
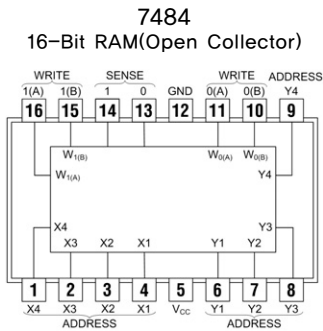
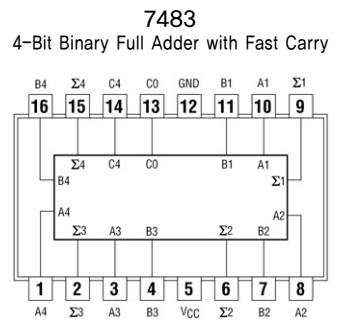
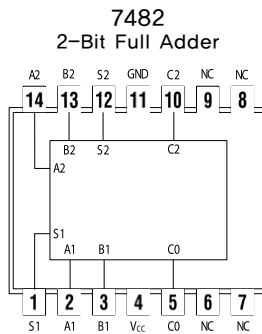
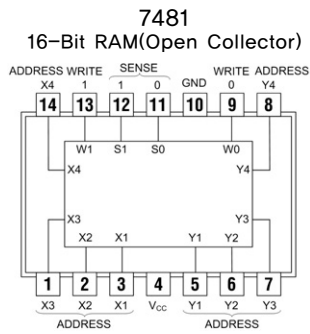
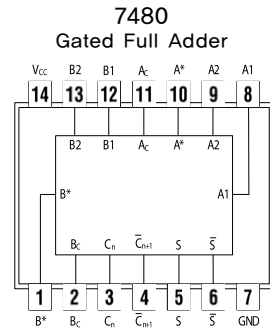
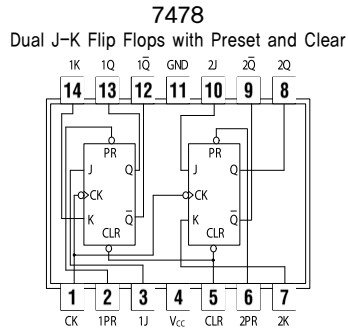
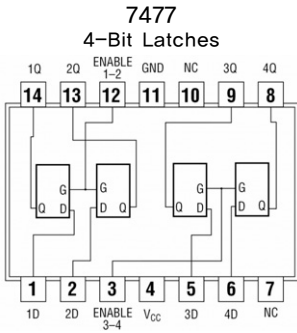

7492
Divide-by-12 Counters

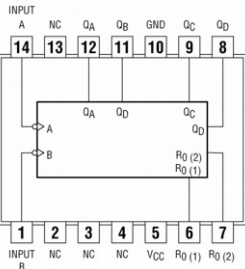

7493
4-Bit Binary Counters

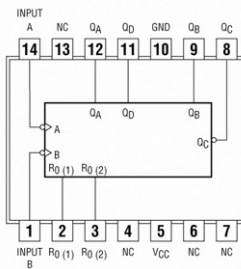

7494
4-Bit Shift Register

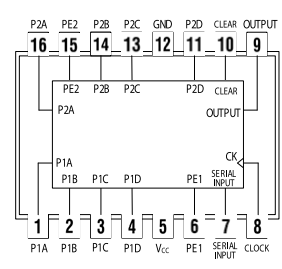

7495
4-Bit Shift Register PIPO

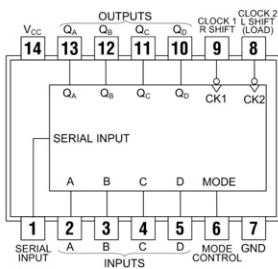

7496
5-Bit Shift Register PIPO

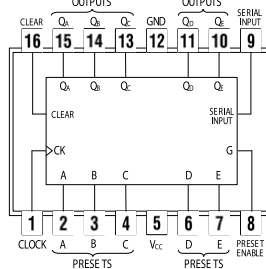

7497
6-Bit Synchronous Binary Rate Multipliers

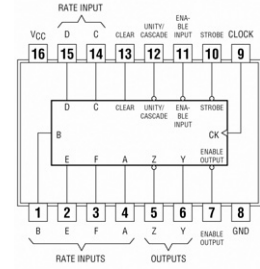

74100
8-Bit Latches

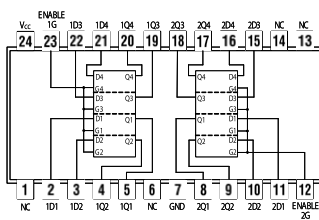

74107
Dual J-K Flip Flops with Clear

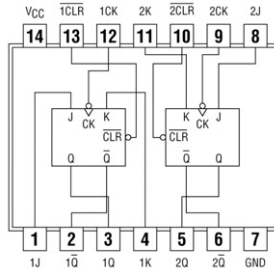

74109
Dual J-K Flip Flops with Preset and Clear

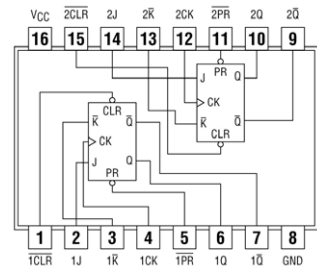

74112
Dual J-K Flip Flops with Preset and Clear

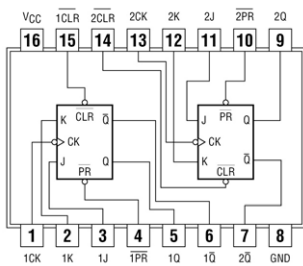

74113
Dual J-K Flip Flops with Preset

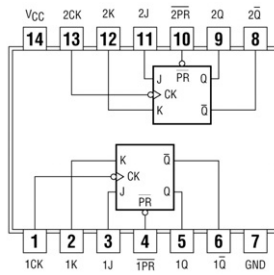

74114
Dual J-K Flip Flops with Preset and Clear

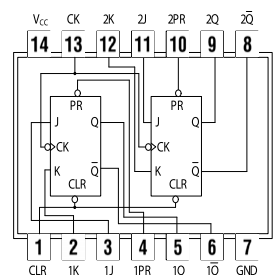

74121
Monostable Multivibrators

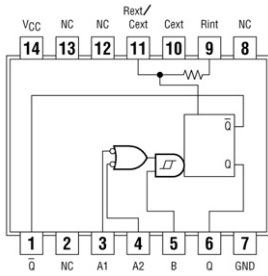

74122
Monostable Multivibrators with Clear

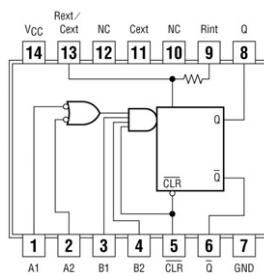

74123
Dual Monostable Multivibrators with Clear

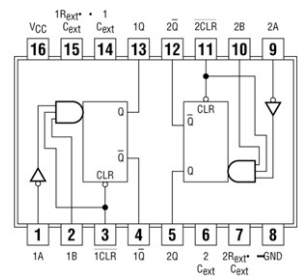

74125
Quad Bus Buffer Gates 3-State

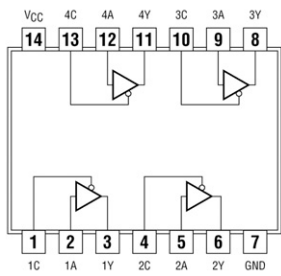

74126
Quad Bus Buffer Gates 3-State

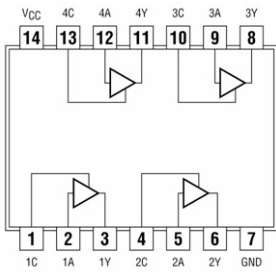

74132
Quad 2-Input NAND Schmitt Triggers

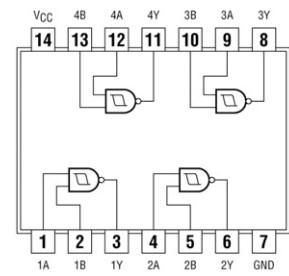

74133
13-Input NAND

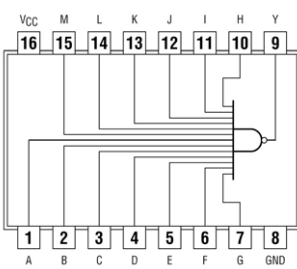

74134
12-Input 3 States NAND

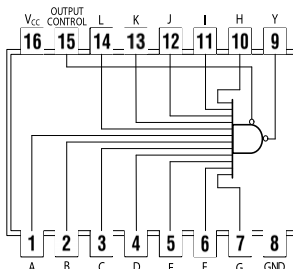

74135
Quad 2-Input XOR/XNOR

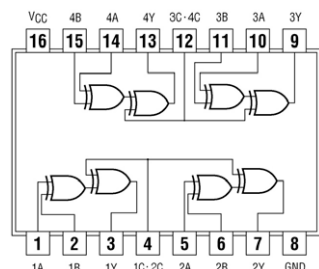

74136
Quad 2-Input XOR O.C.

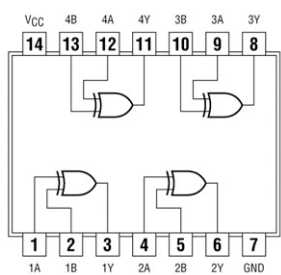

74137
3-to-8 Line Decoders/Demultiplexers Latch

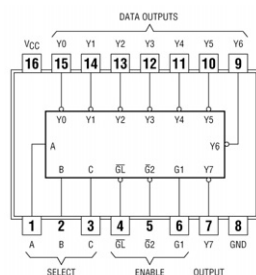

74138
3-to-8 Line Decoders/Demultiplexers

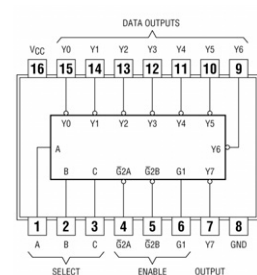

74139
Dual 2-to-4 Line Decoders/Demultiplexers

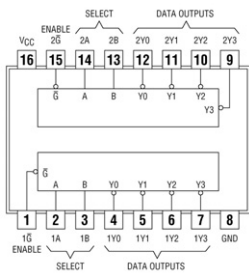

74140
Quad 4-input NAND Line Driver(50Ω)

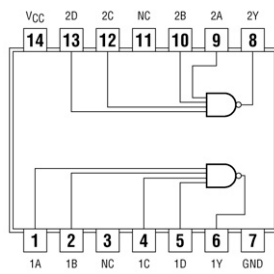

74145
BCD-to-Decimal Decoders/Drivers O.C.

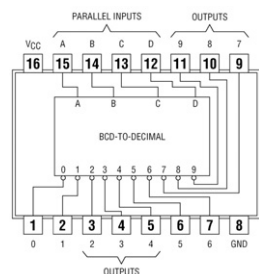

74147
10-to-4 Line Priority Encoder

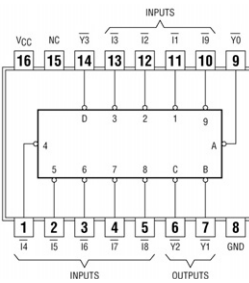

74148
8-to-3 Line Priority Encoders

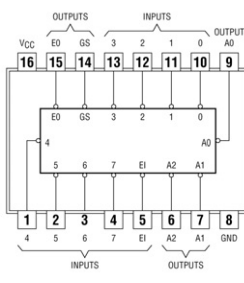

74150
16-to-1 Line Data Selector

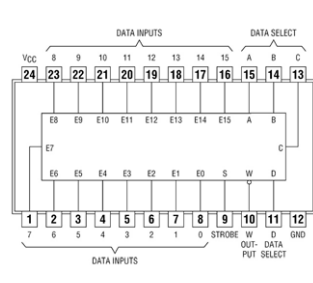

74151
8-to-1 Line Data Selectors/Multiplexers

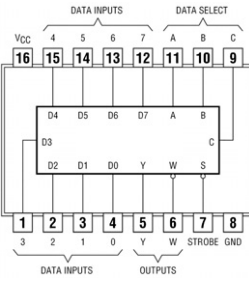

74152
8-to-1 Line Data Selector

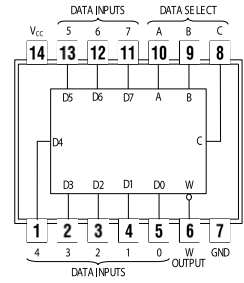

74153
Dual 4-to-1 Line Data Selectors/Multiplexers

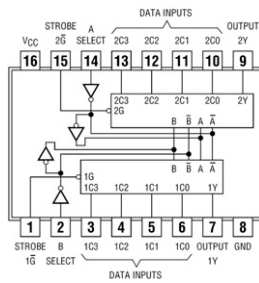

74154
4-to-16 Line Decoders/Demultiplexer

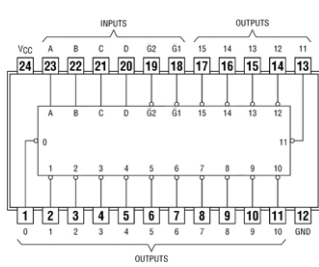

74155, 74156
Dual 2-to-4 Line Decoders/Demultiplexers

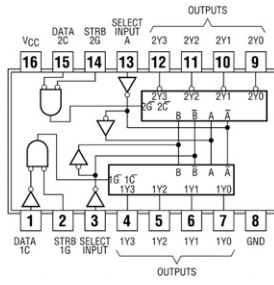

74157, 74158
Quad 2-to-1 Line Data Selectors/Multiplexers

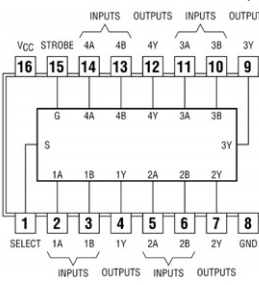

74160, 74162
Synchronous Presettable BCD Counter with Clear

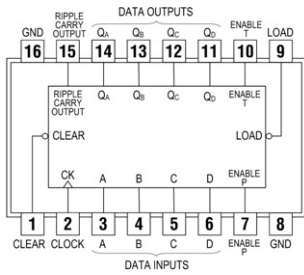

74161, 74163
Synchronous 4-bit Binary Counters

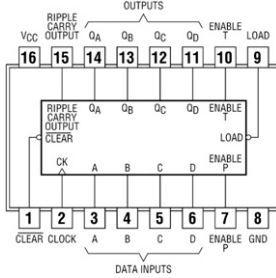

74164
8-Bit Shift Registers (P-Out Serial)

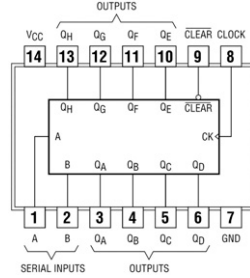

74165
8-Bit Shift Registers(P-Load)

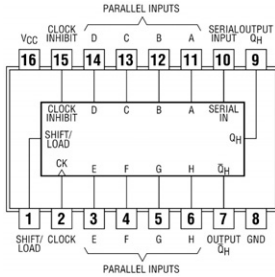

74166
8-Bit Shift Registers(P-Load)

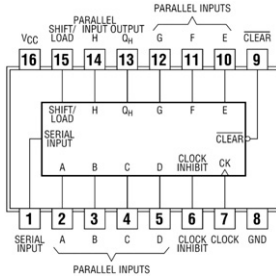

74168, 74169
BCD/Decade Synchronous Up-Down Counters

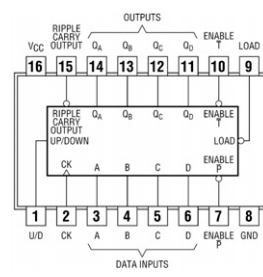

74170
4-by-4 Register Files

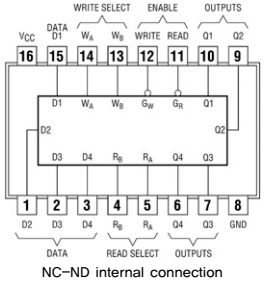

74173
4-Bit D-Type Registers

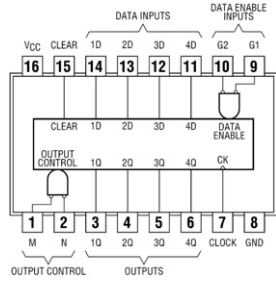

74174
Hex D-Type Flip Flops

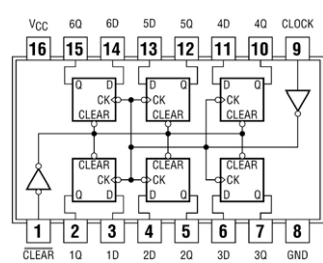

74175
Quad D-Type Flip Flops

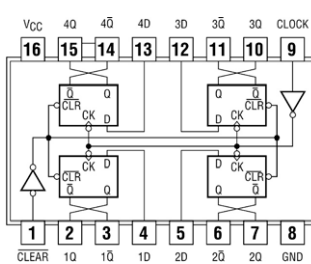

74176, 74177
Presettable Decade Counter
Presettable Binary Counter

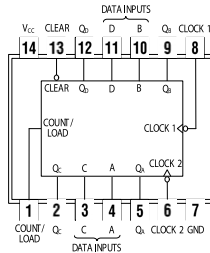

74178
4-Bit Register PIPO

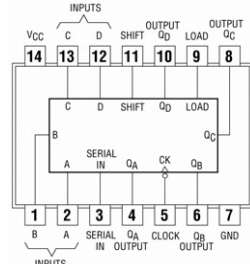

74179
4-Bit Shift Register PIPO

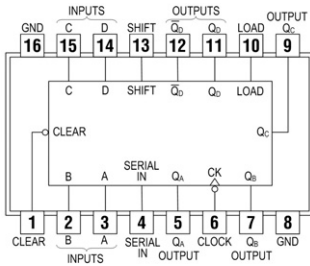

74180
8-Bit Parity Generator

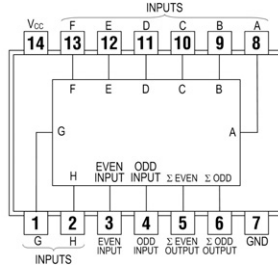

74181
4-Bit ALU/Function Generators

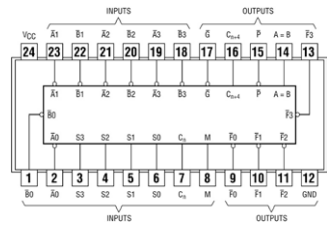

74182
Look-Ahead Carry Generators

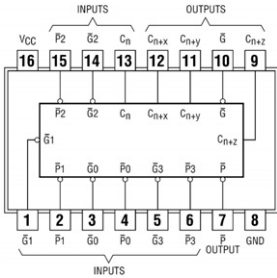

74183
Dual Carry Save Full Adders

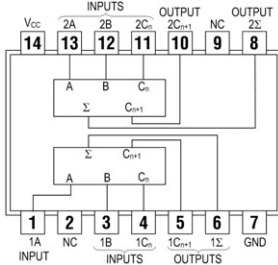

74190, 74191
Presettable Synchronous Up/Down Decade Counter

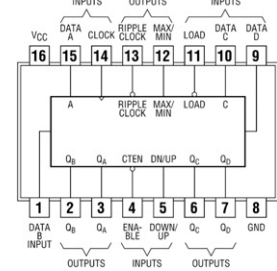

74192
Presettable Synchronous 4-Bit Up/Down Counters

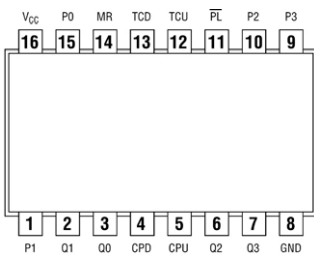

74193
Presettable Synchronous Up/Down Dual Clock Counters

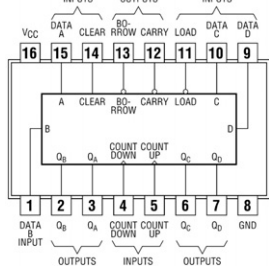

74194
4-Bit Bidirectional Universal Shift Registers

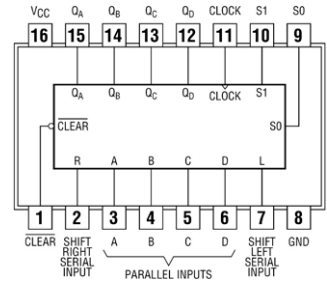

74195
4-Bit Parallel Access Shift Registers

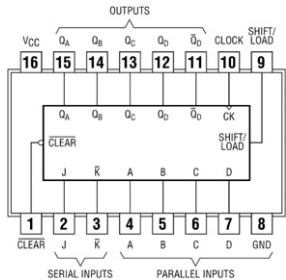

74196, 74197
Presettable Decade Counter
Presettable Binary Counter

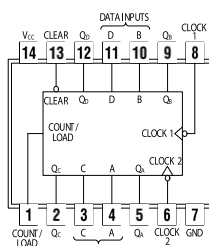

74198
8-Bit Bidirectional Shift Register PIPO

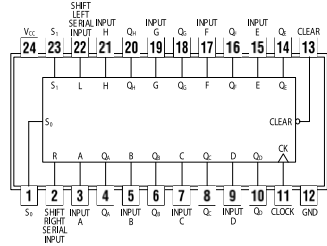

74199
8-Bit Shift Register PISO

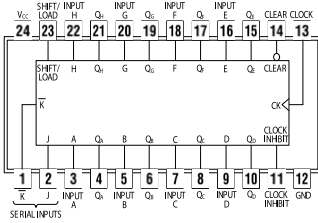

74221
Dual Monostable Multivibrators

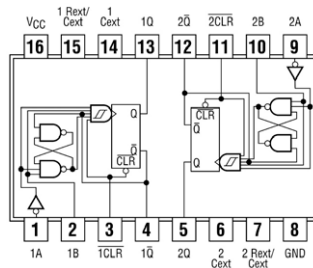

74224
16x4 Synchronous FIFO Memory with 3-State Outputs

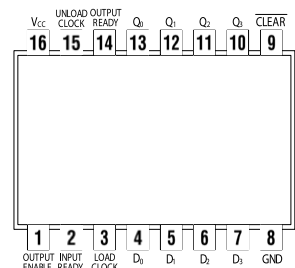

74238
3-to-8-Line Decoders/Demultiplexers

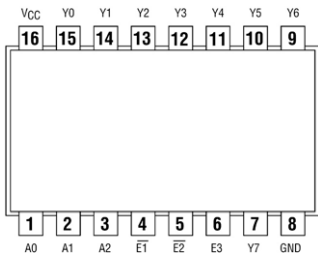

74240
Octal Bus Drivers 3-State

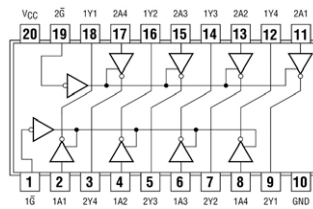

74241
Octal Bus Drivers 3-State

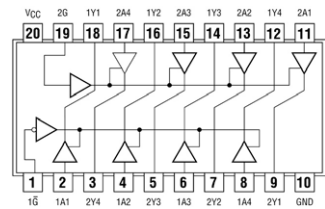

74242
Quad Bus Transceiver

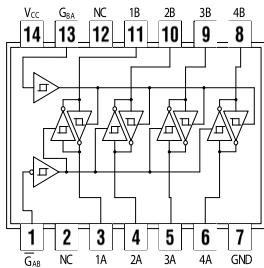

74243
Quadruple Bus Transceivers

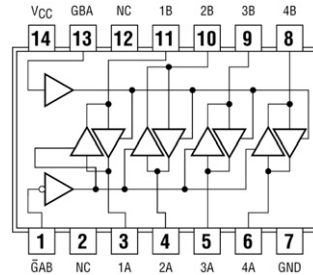

74244
Octal Bus Drivers 3-State

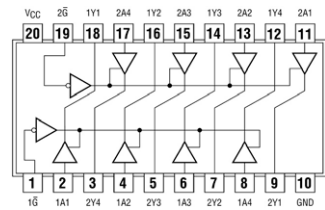

74245
Octal Bus Transceivers 3-State

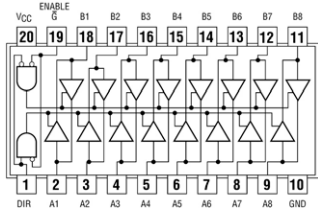

74246, 74247
BCD-to-Seven Segment Decoders

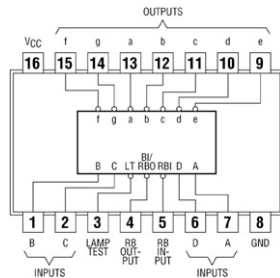

74248, 74249
BCD-to-Seven Segment Decoders

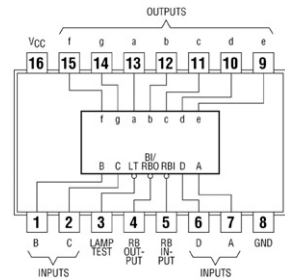

74251
Data Selectors/Multiplexers 3-State

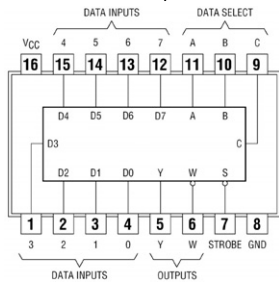

74253
Dual 4-to-1 Line Data Selector/Multiplexers 3-State

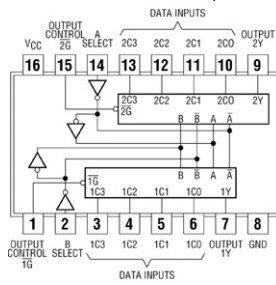

74256
Dual 4-Bit Addressable Latch

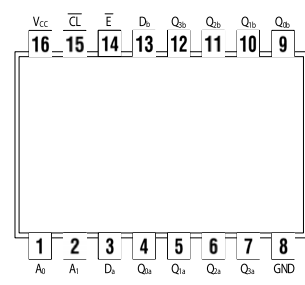

74257
Quad 2-to-1 Data Selector/Multiplexers 3-State

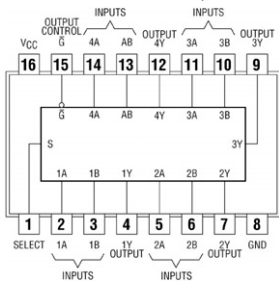

74258
Quad 2-to-1 Data Selector/Multiplexers 3-State

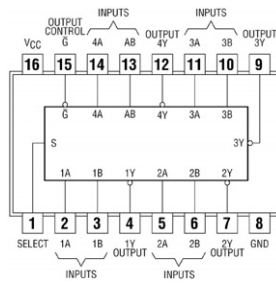

74259
8-Bit Addressable Latches

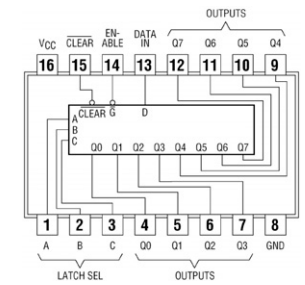

74260
Dual 5-Input NOR Gates

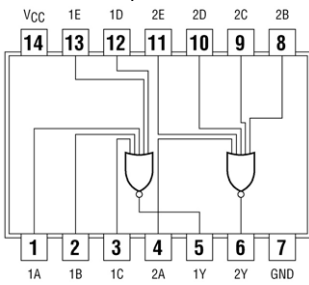

74266
Quad 2-Input XNOR O.C.

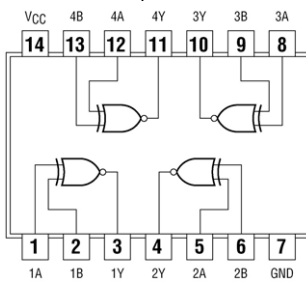

74273
Octal D-Type Flip Flops

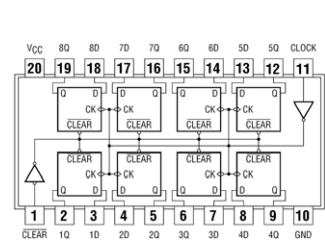

74276
Quad J-K Flip Flops

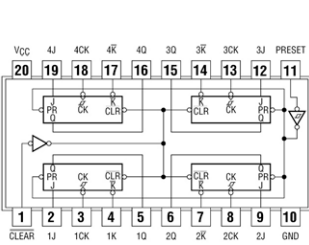

74279
Quad S-R Latches

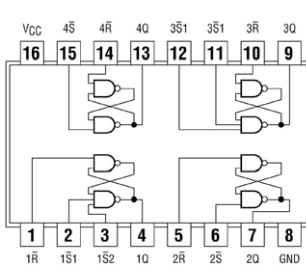

74280
9-Bit Parity Generators/Checkers

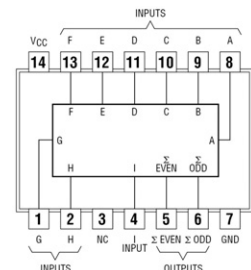

74283
4-Bit Binary Full Adders

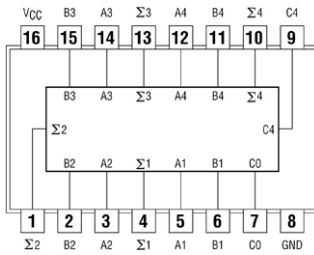

74286
9-Bit Parity Generators/Checkers

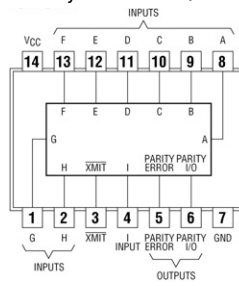

74290
Decade Counter

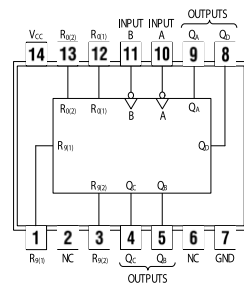

74293
4-Bit Binary Counters

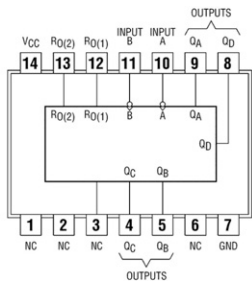

74295
4-Bit Shift PIPO 3-State

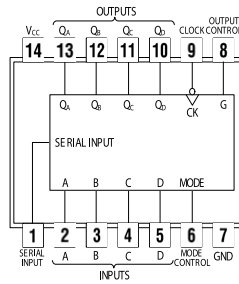

74298
Quad 2-Input Multiplexers with Storage

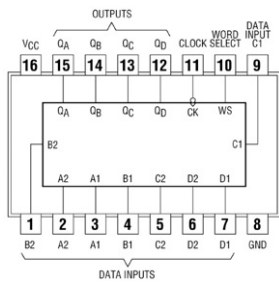

74299, 74323
8-Bit bidirectional Universal Shift/Storage Registers

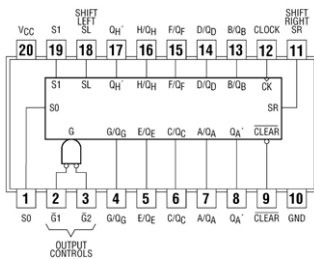

74322
8-Bit Shift Register with Sign Extend

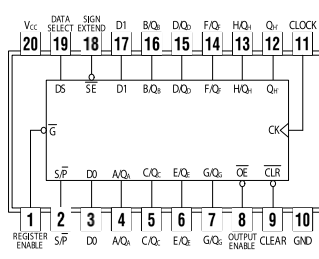

74348
8-to-3 Line Priority Encoder

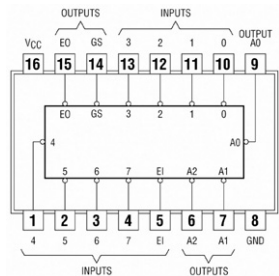

74352
Dual 4-to-1 Line Data Selector

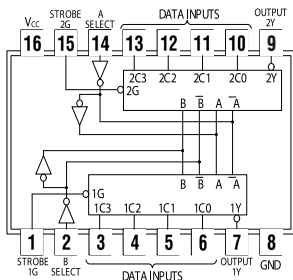

74353
Dual 4-to-1 Line Data Selector 3-State

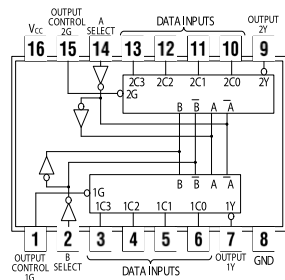

74365
Hex Bus Drivers Hex Buffers/Line Drivers 3-State

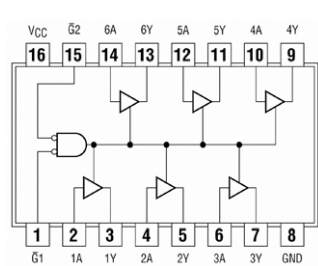

74366

Hex Bus Drivers Hex inverters/Line Drivers 3-State

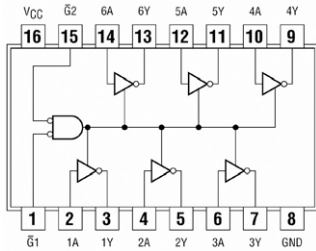

74367

Hex Bus Drivers Hex Buffers/Line Drivers 3-State

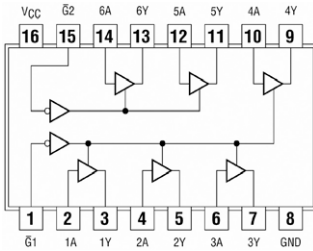

74368

Hex Bus Drivers Hex inverters/Line Drivers 3-State

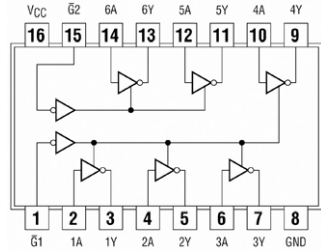

74373

Octal D-Type Latches 3-State

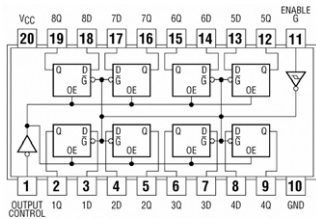

74374

Octal D-Type Flip Flops 3-State

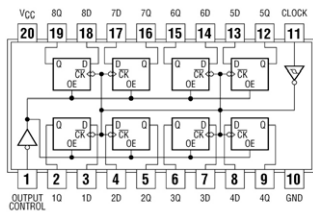

74375

Quad Latches

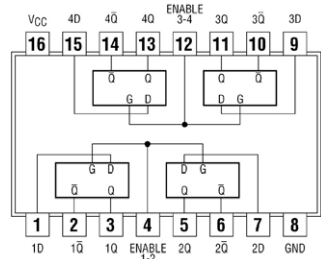

74376

Quad J-K Flip Flops

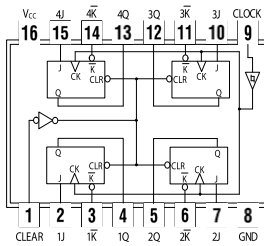

74377

Octal D-Type Flip Flops with Enable

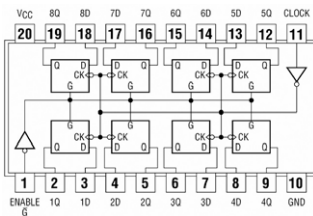

74378, 74174

Hex D-Type Flip Flops Clock with Enable

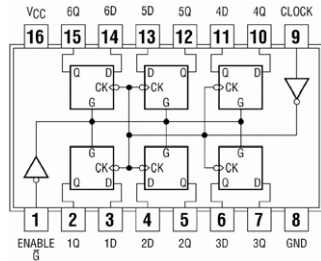

74379, 74175
Quad D-Type Flip Flops with Enable

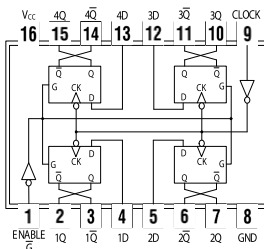

74381, 74382
ALU/Function Generator

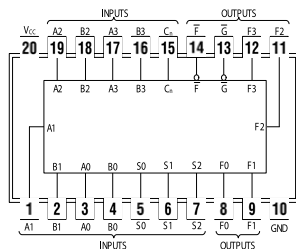

74386
Quad 2-Input XOR

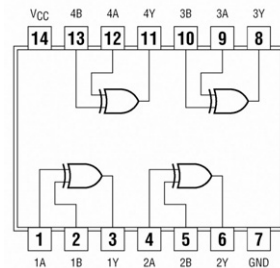

74390
Dual Decade Counters

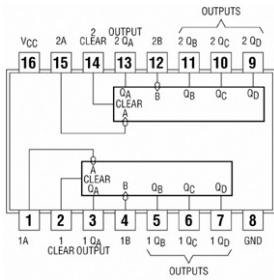

74393
Dual 4-Bit Binary Counters

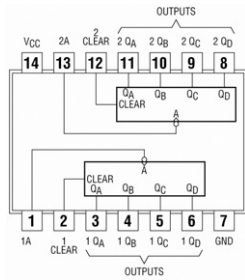

74395
4-Bit Shift Register PIPO

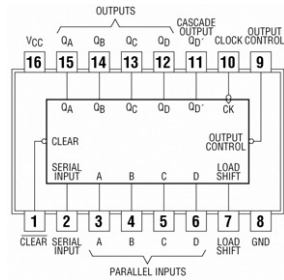

74396
Octal Storage Register

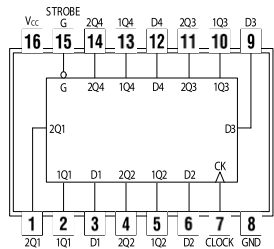

74398
Quad 2-Input Multiplexer with Storage

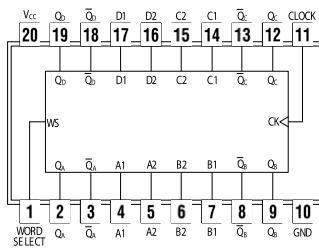

74399
Quad 2-Input Multiplexer with Storage

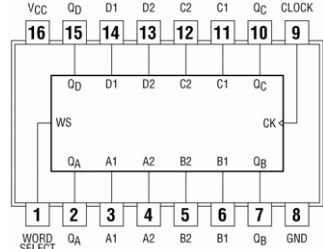

74422
Monostable Multivibrator

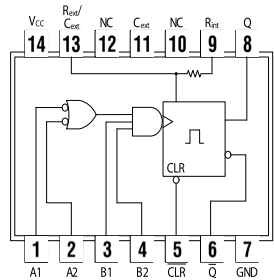

74423
Mono Stable Multivibrator

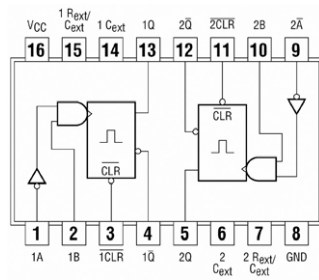

74425
Quad 3-State Buffers

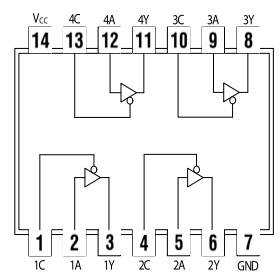

74426
Quad 3-State Buffers

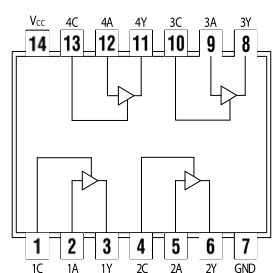

74440, 74441, 74442, 74443, 74444
Quadruple Tridirectional Bus Transceivers

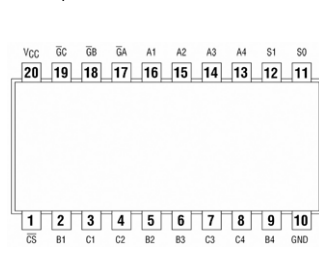

74490
Dual Decade Counters

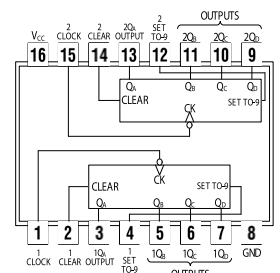

74520, 74521, 74688, 74689
8-Bit Identity Comparator

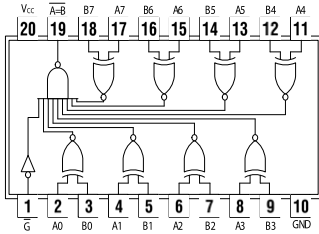

74534
Octal D-Type Edge-triggered Flip Flops

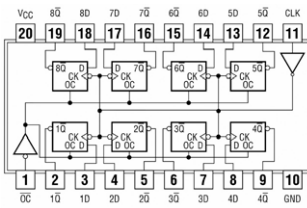

74540, 74541
Octal Buffers/Drivers 3-State

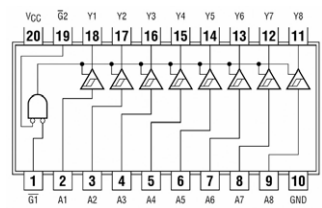

74543
Octal Registered Transceivers

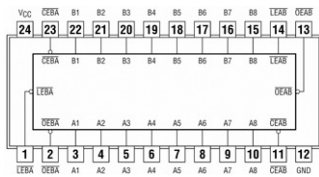

74564
Octal D-Type Flip Flops

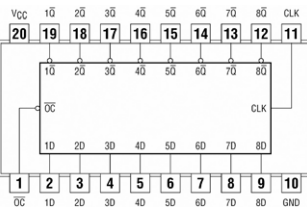

74569
Synchronous Binary Counter 3-State

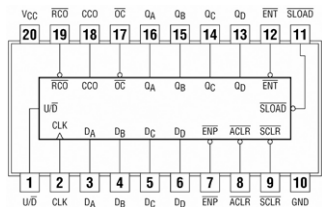

74573
Octal D-Type Latches

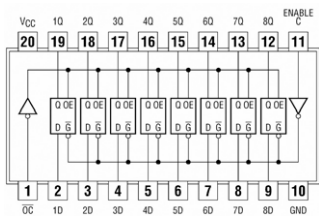

74574
Octal D-Type Edge-triggered Flip Flops

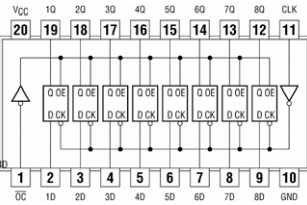

74575
Octal D-Type Edge-triggered Flip Flops

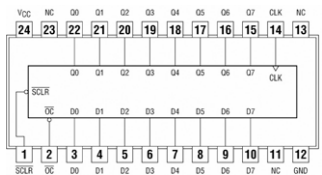

74595, 74596
8-Bit Shift Registers

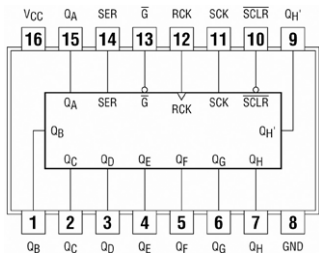

74597
8-Bit Shift Registers

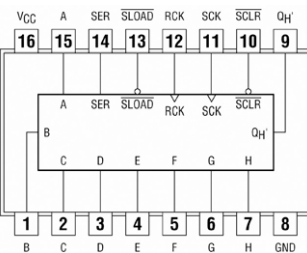

74620, 74621, 74623
Octal Bus Transceivers 3-State

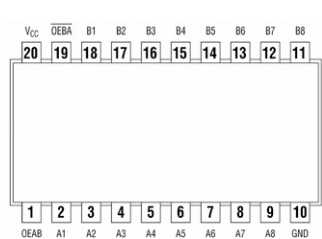

74622
Octal Bus Transceiver O.C.

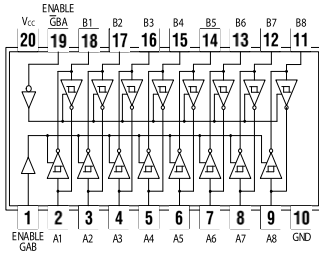

74638
Octal Bus Transceivers

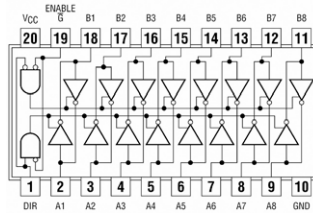

74639
Octal Bus Transceivers

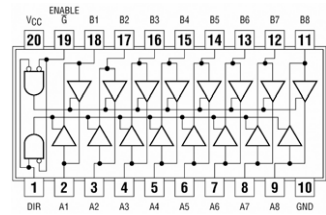

74640, 74642
Octal Bus Transceivers 3-State

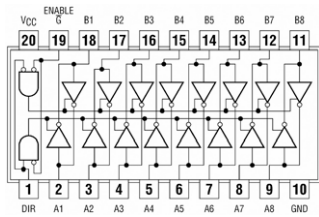

74641, 74645
Octal Bus Transceivers O.C.

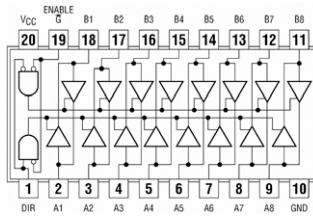

74643, 74644
Octal 3-State Bus Transceivers

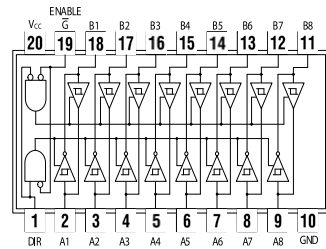

74646, 74647, 74648
Octal Bus Transceivers and Registers

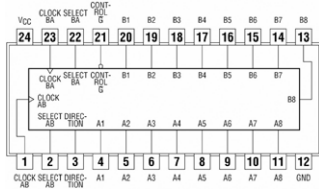

74651, 74652, 74653, 74654
Octal Bus Transceivers and Registers

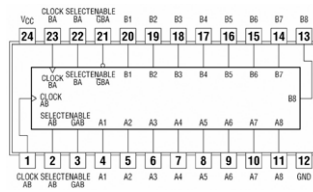

74668, 74669
Presettable Synchronous 4-Bit Up/Down Binary Counter

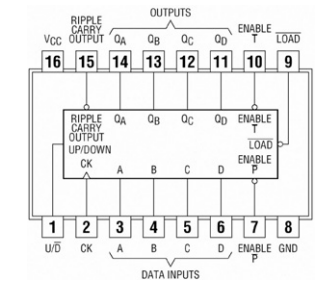

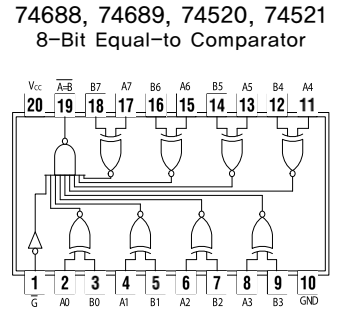
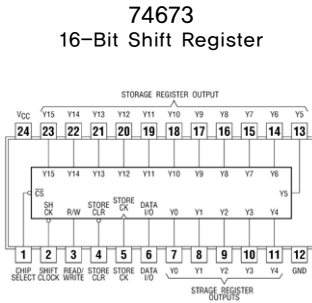
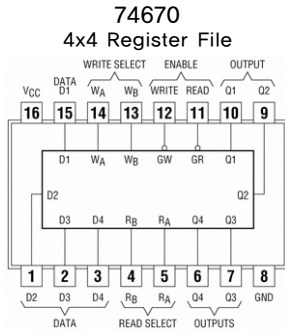

74843
9-Bit Bus Interface D-type Latches with 3-state Outputs

